



OG8106/P - Lincat Opus 800 Propane Gas Free-standing Single Tank Fryer - 2 Baskets - W 400 mm - 23.0 kW

The incredibly accurate Opus 800 Single-Tank Free Standing Gas Fryer comes with an accurate thermostatic control that goes up to 190°C, ensuring consistent results and safe operation.

- ✓ Accurate thermostatic control up to 190°C for consistent results and safe operation
- ✓ Externally fired heating gives easy access for cleaning tanks
- ✓ Convenient piezo ignition

Specifications

Summary

Brand	Lincat
Range	Opus 800
Power Type	Gas
Gas Type	Propane Gas
Unit Type	Free-standing
Available in UK Only	No
UK Warranty	2 Years Parts and Labour Warranty
Export Warranty	Contact your local dealer
GTIN	5056105103042

Power and Performance

BTU per Hour	78,476
Total Power kW	23.0
Temperature Range °C	90-190
Temperature Control	Mechanical

Key Specifications

Number of Baskets	2
Number of Tanks	1
Gravity Filtration	No
Pumped Filtration	No
Drain Location	Through the body

Capacity

Product Output per Hour	28kg chips - 12mm [frozen], 34kg chips - 12mm [chi]
Capacity Litres	16.0

Weights and Dimensions

Unit Height (External) mm	1020
Unit Width (External) mm	400
Unit Depth (External) mm	800
Net Weight Kg	88.1

Supply Connections

Requires Installation	Yes
Requires Electrical Supply	No
Gas Connection BSP	1/2"
Gas Consumption at full rate Propane m³ per Hour	1.64
Gas Pressure Propane mbar	37.0
Total heat input at full rate Propane kW	23.0
Total heat input at full rate Propane BTU per hour	78,479

Shipping

Packed Weight Kg	98.1
Packed Height cm	122
Packed Width cm	85
Packed Depth cm	45

Available Accessories

BA82	BASKET LARGE
LK02	OPUS 350 LEG KIT
OA8955	SPLASHGUARD FRYERS - OPUS 800

Available Accessories

OF2

Oil filter kit - size 2

Technical Picture

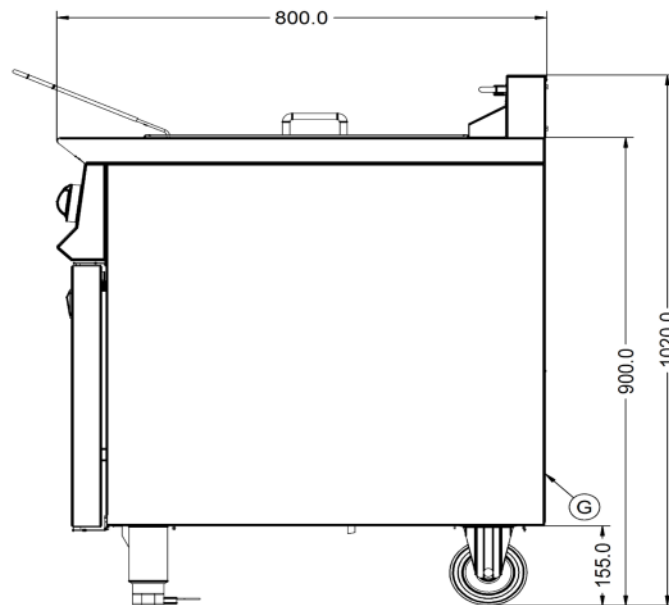
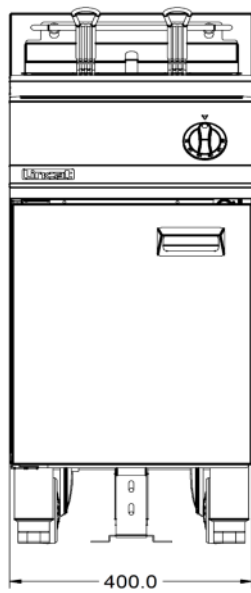
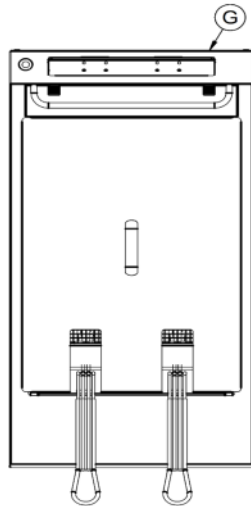



Lincat Limited

Whisby Road,
Lincoln, LN6 3QZ,
United Kingdom

Company No: 2175448

A member company of



Customer Care

Tel: +44 1522 875500
Email: care@lincat.co.uk

Export Customers

Tel: +44 1522 875536
Email: export@lincat.co.uk

Opening Hours

Monday – Friday:
8.30am – 5pm